

**AGES 8+**  
19509/19495Asst.

Before assembly and playing, please read instructions. Please keep these instructions for future reference.

**BB-40**  
**BALANCE**  
**DARK BULL™ H145SD**

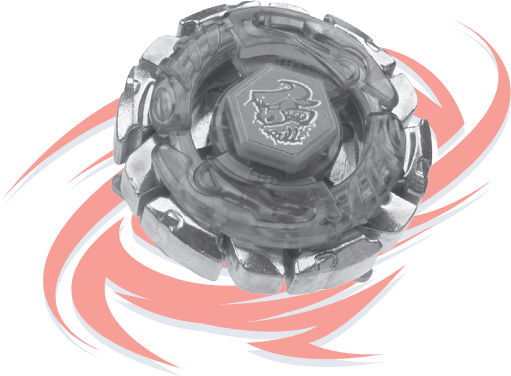

Includes 5-piece top, Ripcord Launcher™\* & assembly tool.

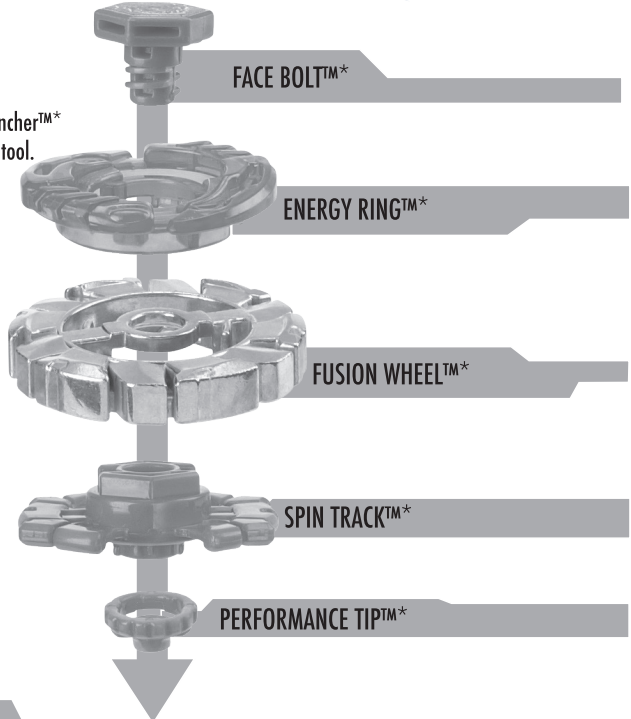

**⚠ WARNING:**  
Do not use Beyblade™ tops or Beystadium™ (sold separately) on tables or other elevated surfaces.

### APPLY LABELS AS SHOWN

Remove temporary decals and apply permanent decals as shown.

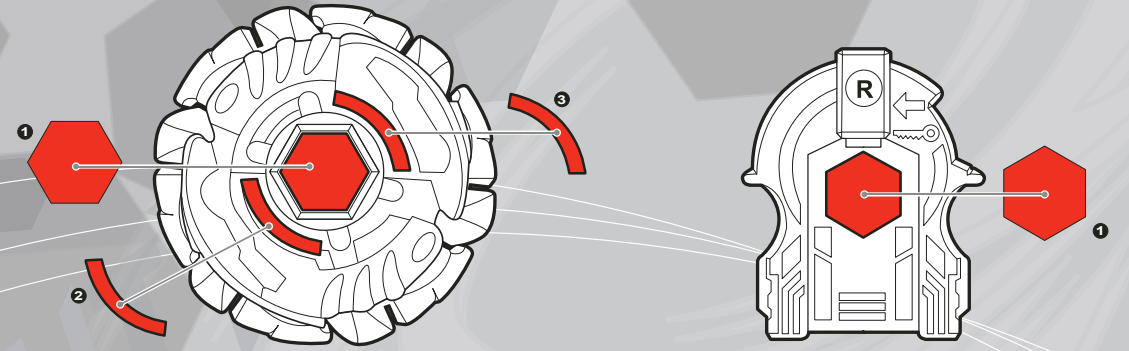

### ASSEMBLY:

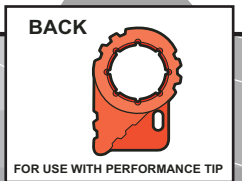
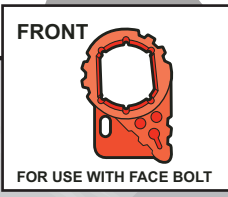
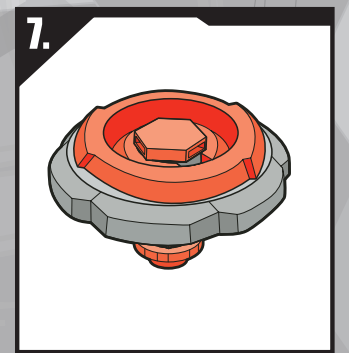
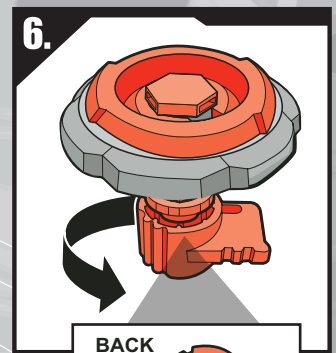
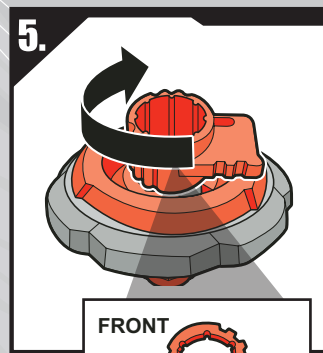
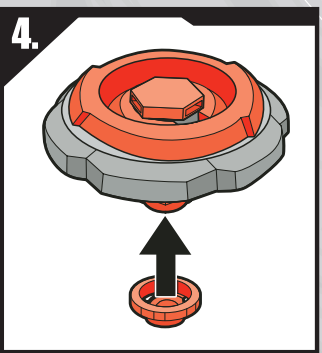
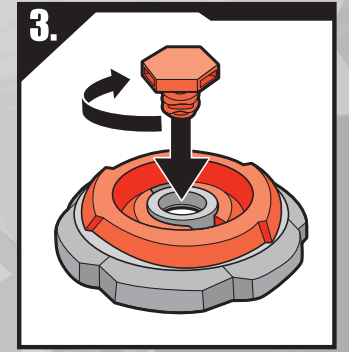
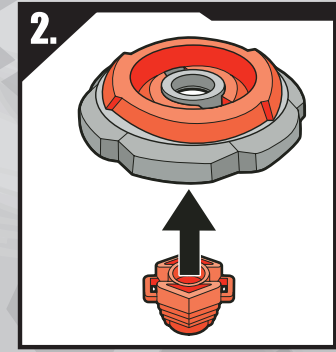
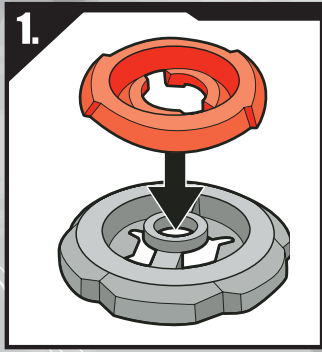

## TO LAUNCH:

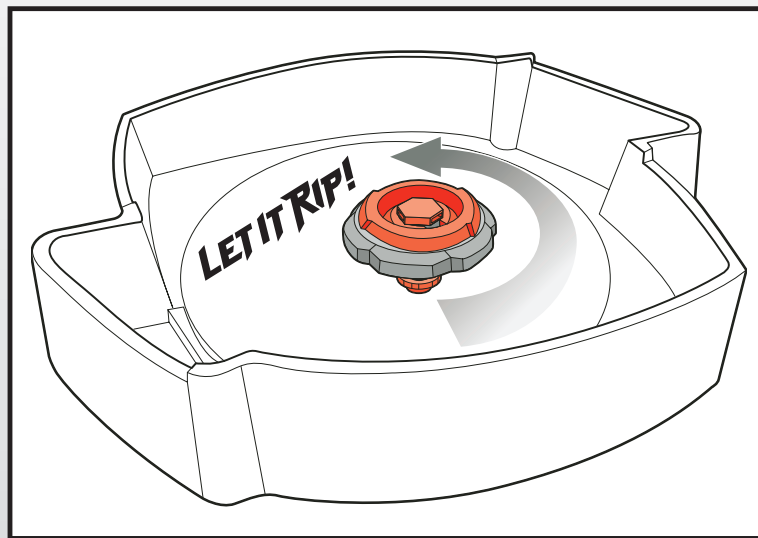
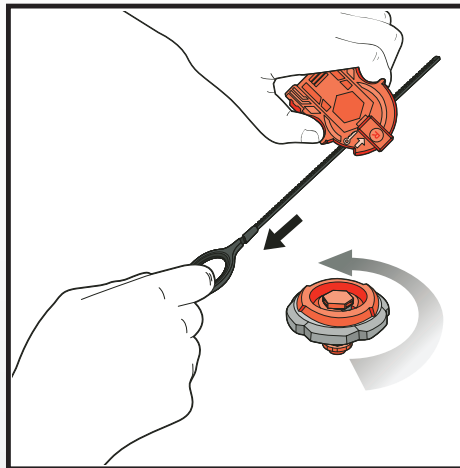
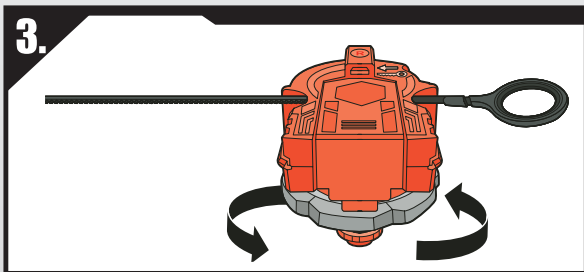
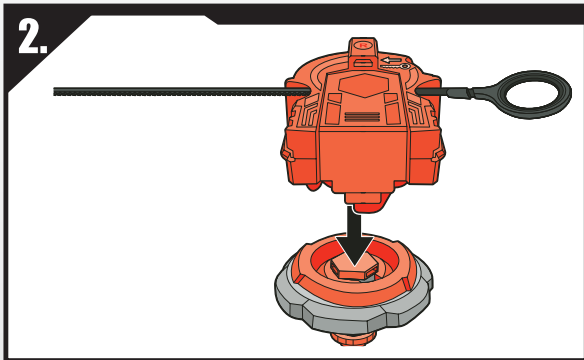
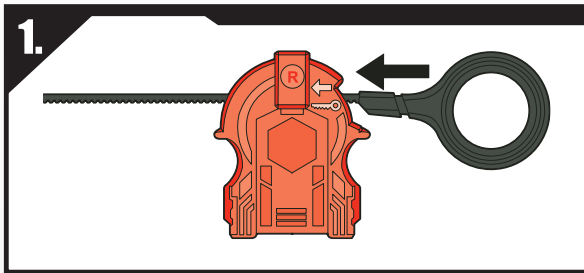

## BATTLE TIPS:

**Collect.** Each type of top (attack, defense, stamina, balance) performs differently, so it's good to have different types. That way, you are ready to battle any top.

**Customize.** Customizing your tops will make them perform differently. Experiment and see how to enhance their performance by switching parts.

- What kind of top does your opponent have, and what will be the best way to defeat it? Do you need an attack top or one with stamina? Is a defense top your best option, or a top with balance?
- What kind of stadium are you using? Familiarize yourself with the different types of stadiums, so you will know which kind of top will work best in it.
- Learn more at [www.BeyBladeBattles.com](http://www.BeyBladeBattles.com)!†

**Compete.** Figure out what type of top you're battling so you can choose the best top and strategy to win.

**Battle at BeyBladeBattles.com!†**

## TRIPLE SHOT BATTLES:

**You and your opponent battle 3 Beyblade tops!**

- Assemble your tops.
- Decide the order in which you'll battle them.
- Complete 3 battles.
- The player who wins 2 out of 3 battles is the winner.

†Web Site Available for a Limited Time



Product and colors may vary.  
© Takafumi Adachi, MFBBProject, TV Tokyo  
Manufactured under license from TOMY Company, Ltd.  
®\* and/or TM\* & © 2010 Hasbro. All Rights Reserved.  
TM & © denote U.S. Trademarks.

PN 7079740000

d-rights

